

4700 SLIDING SYSTEMS

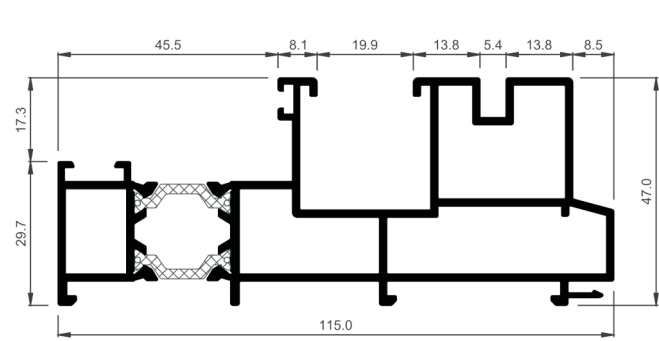

COR-4737 One rail frame with fixed and exterior hook

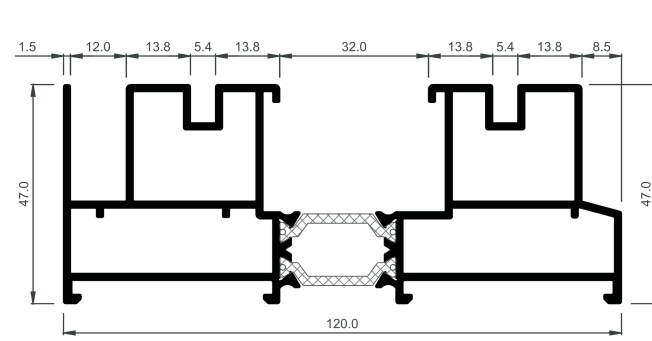

COR-4730 Two rail frame

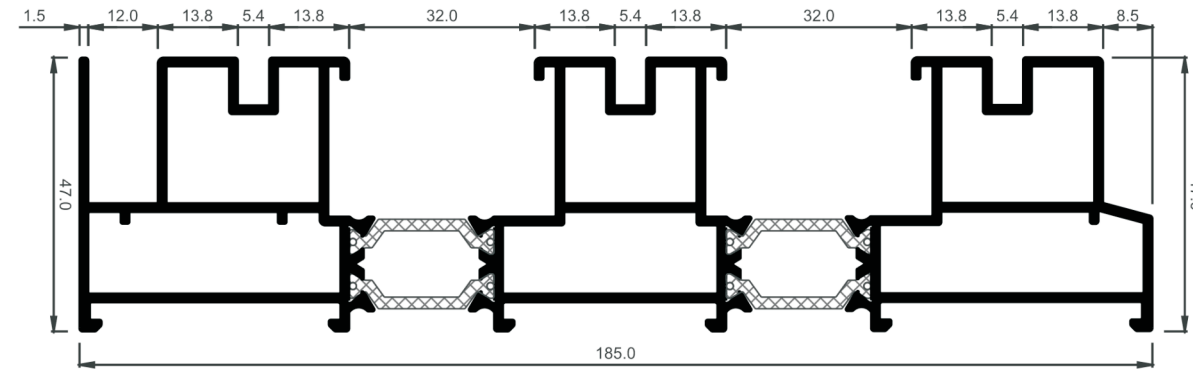

COR-4780 Three rail frame

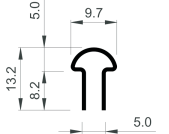

COR-4700
Stainless steel rail

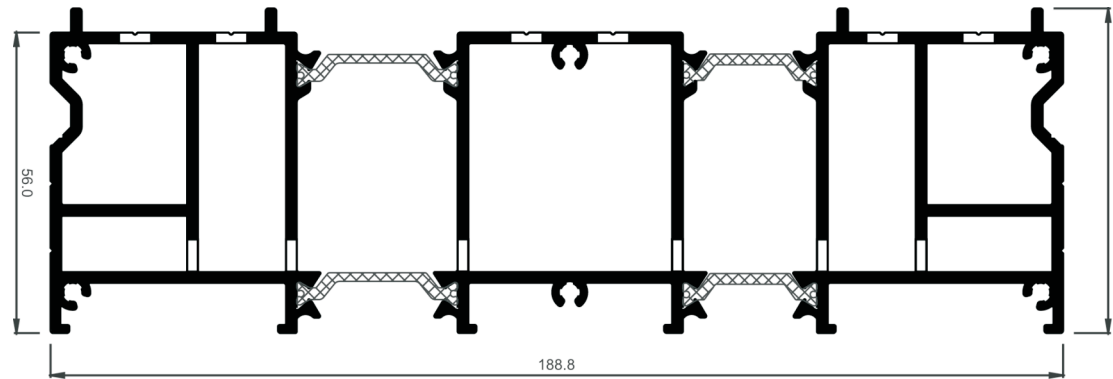

COR-4798 Bottom frame sub sill three rail

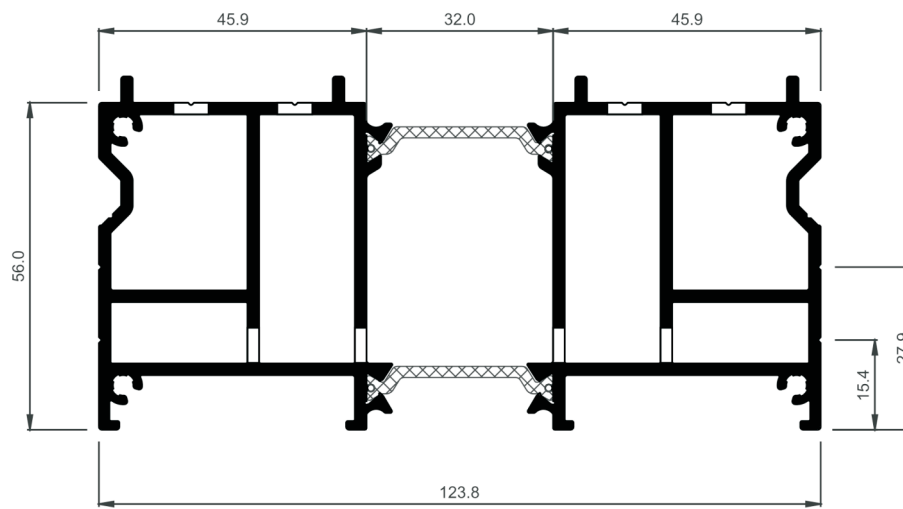

COR-4796 Bottom frame sub sill

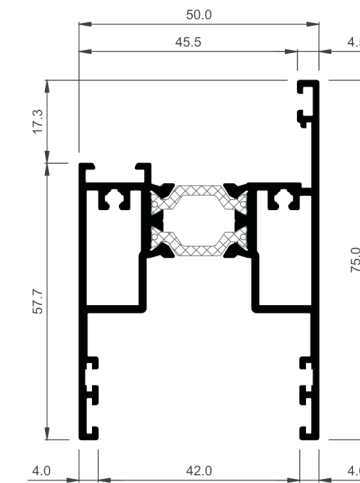

COR-4721 Perimeter sash

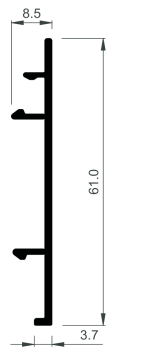

COR-4740 Intersection cover

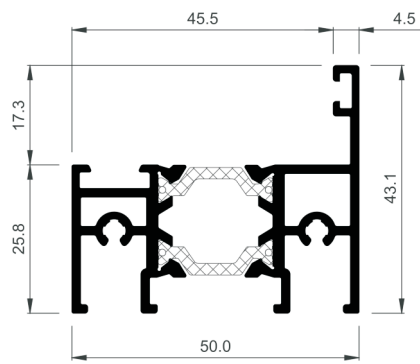

COR-4725 Central sash

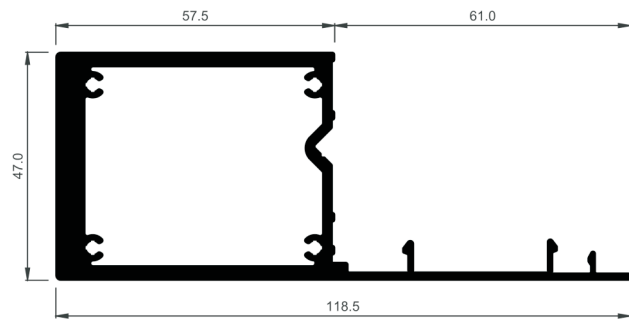

COR-4751 47x57,5 mm reinforcement

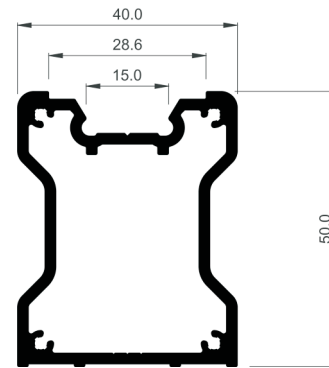

COR-4750 Reinforcement 40x50 mm

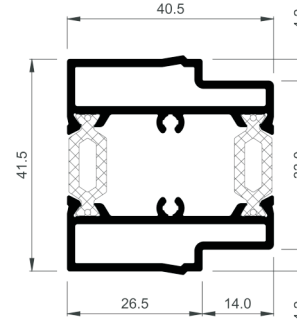

COR-4728 Sash joint profile

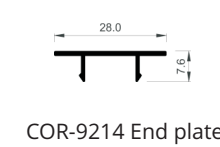

COR-9214 End plate

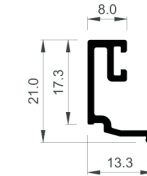

COR-4712 Glazing bead 8 mm

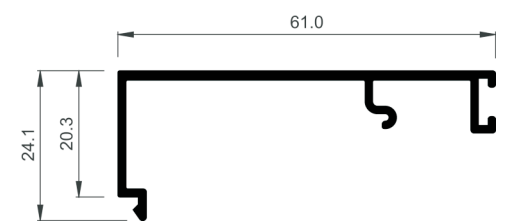

COR-4741 Frame cover for fixed light

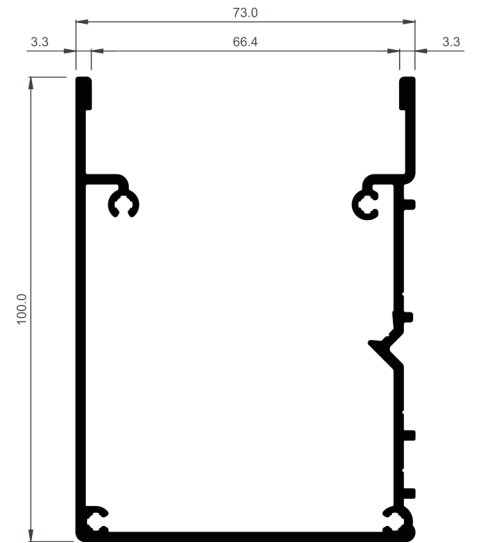

COR-4891 Pickup duct

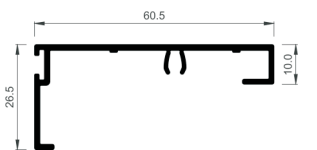

COR-4743 Fixed sash frame cover

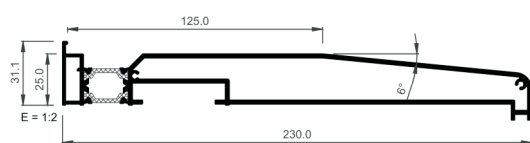

COR-3838 Subcill 230 mm

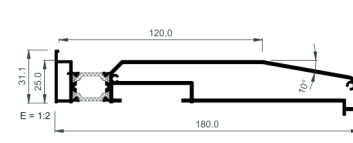

COR-3837 Subcill 180 mm

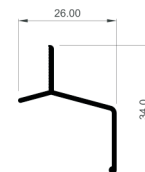

COR-2010
Top rain gutter

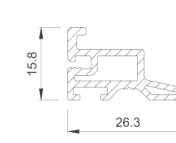

COR-4706
Central sash hem

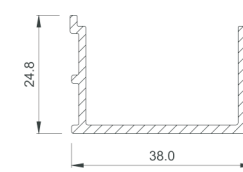

COR-4701
Two rail frame isolation

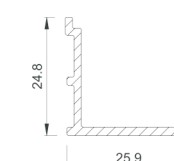

COR-4702
One rail frame
with fixed isolation